

PRODUCT: FASTLANE PLUS S400 OT		
TITLE: GENERAL DIMENSIONS		
DRAWN: RST	DRAWING No: S665_640_A0	
DATE: 20.1.09	This document is the copyright of Integrated Design Ltd	

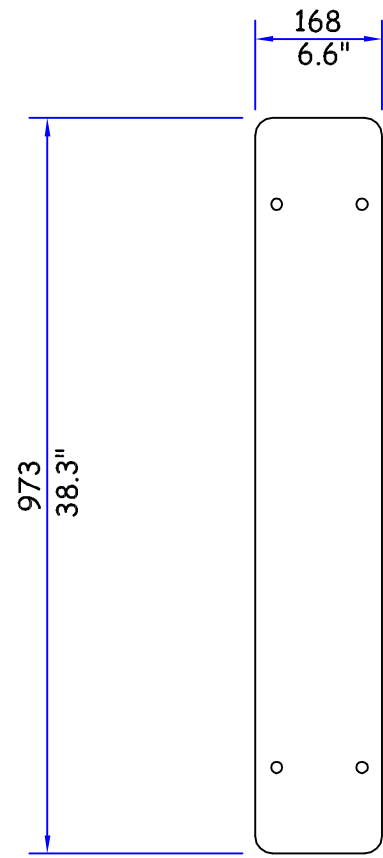

STANDARD LANE WIDTH
PEDESTRIAN ACCESS

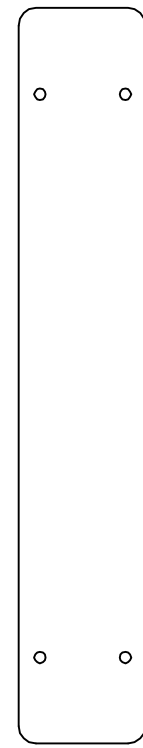

EXTENDED LANE WIDTH
* DISABLED ACCESS

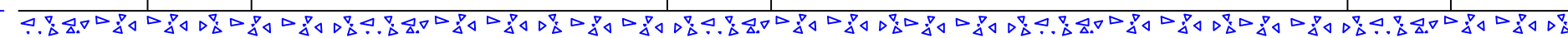
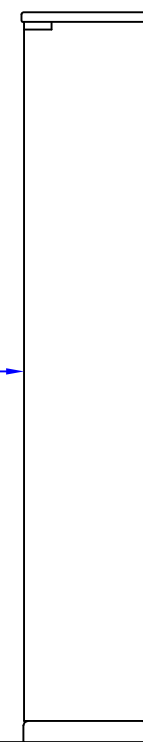
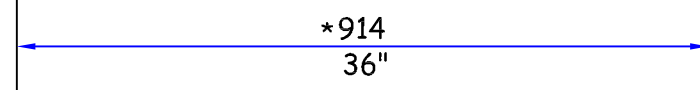
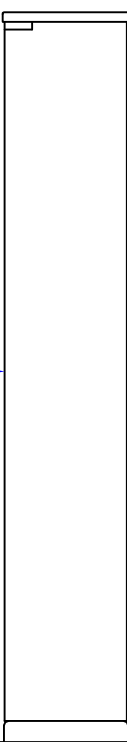
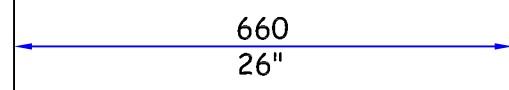
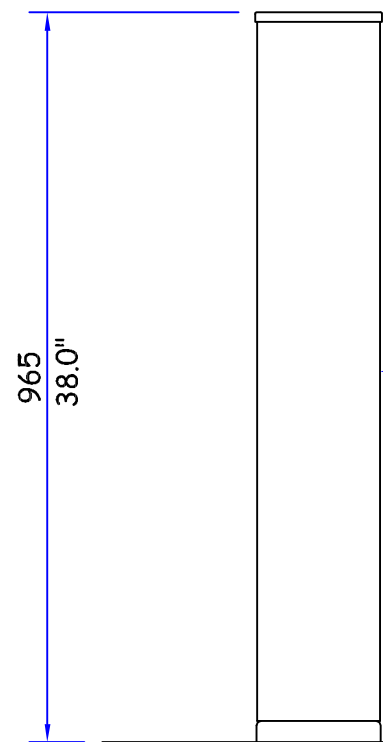

* SUBJECT TO LOCAL LEGISLATION

PRODUCT: FASTLANE PLUS S400 OT	
TITLE: GENERAL LAYOUT	
DRAWN: RST	DRAWING No: S665_641_A1
DATE: 20.1.09	This document is the copyright of Integrated Design Ltd

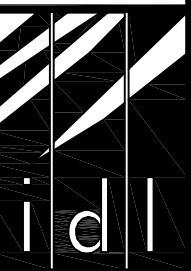

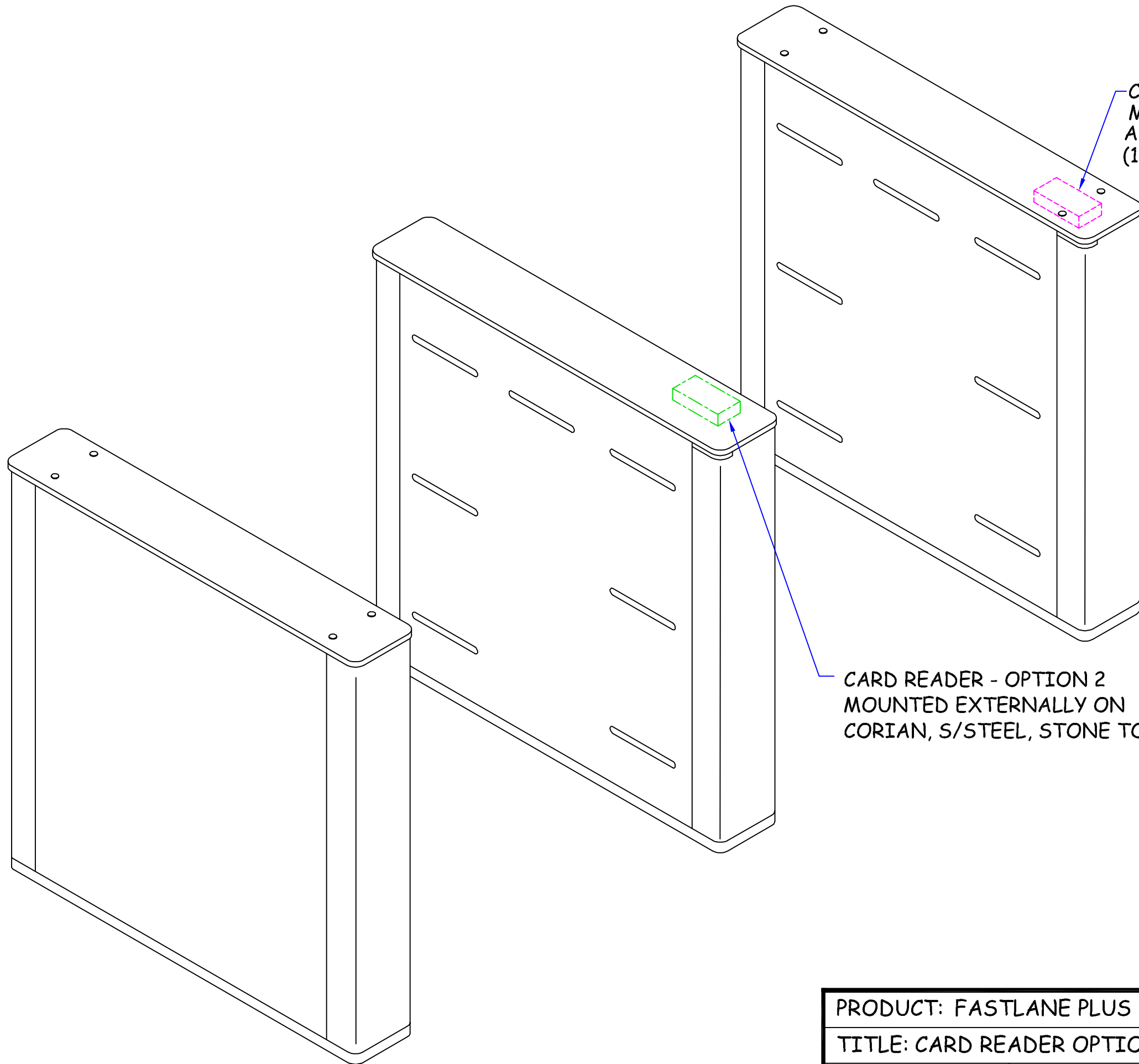

CARD READER - OPTION 1
MOUNTED BELOW GLASS TOP
AVAILABLE AREA 250 x 115 x 70
(10" x 4.5" x 2.75" APPROX.)

CARD READER - OPTION 2
MOUNTED EXTERNALLY ON
CORIAN, S/STEEL, STONE TOP

PRODUCT: FASTLANE PLUS S400 OT	
TITLE: CARD READER OPTIONS	
DRAWN: RST	DRAWING No: S665_643_A0
DATE: 20.1.09	This document is the copyright of Integrated Design Ltd



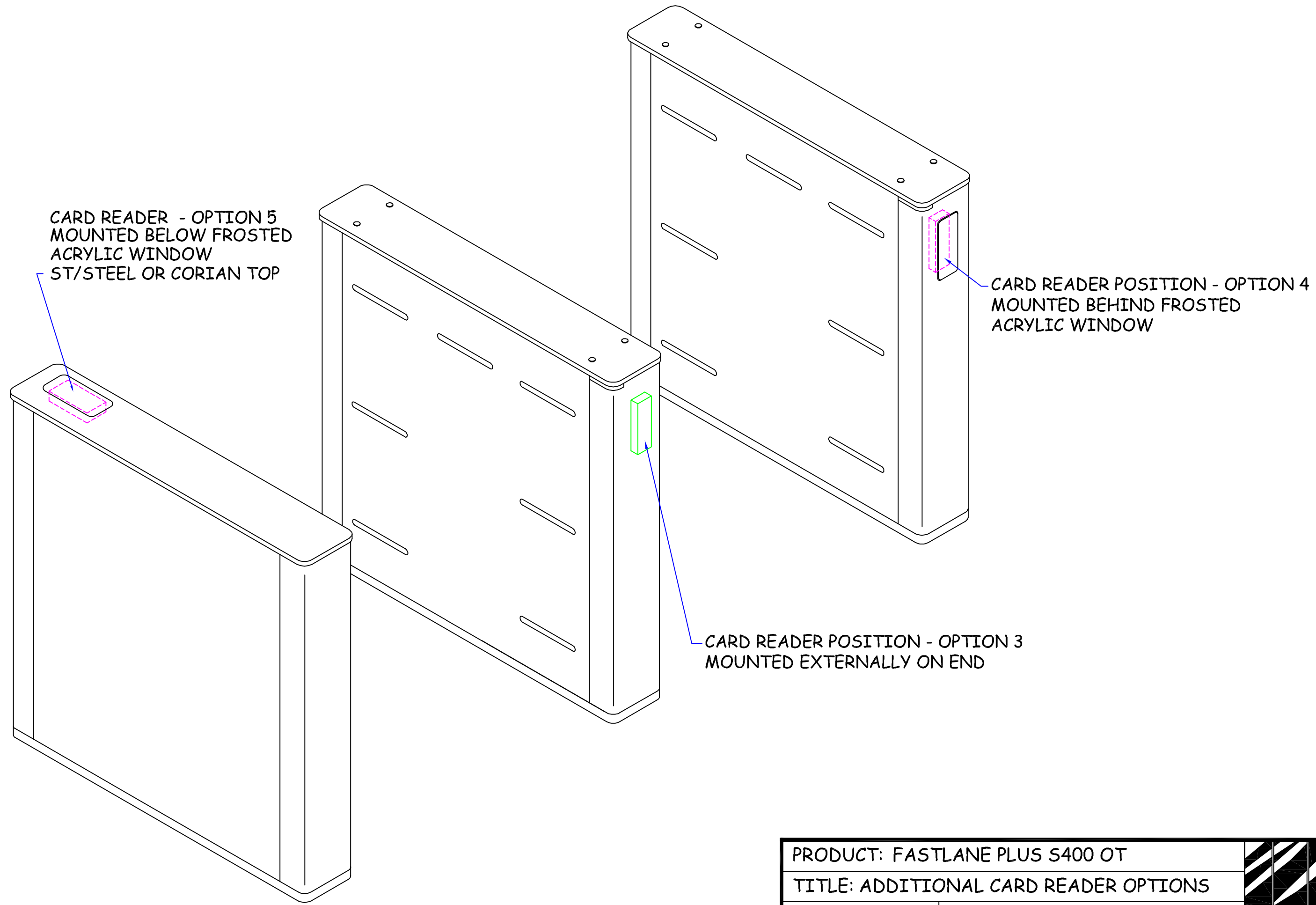

CARD READER - OPTION 5
 MOUNTED BELOW FROSTED
 ACRYLIC WINDOW
 ST/STEEL OR CORIAN TOP

CARD READER POSITION - OPTION 4
 MOUNTED BEHIND FROSTED
 ACRYLIC WINDOW

CARD READER POSITION - OPTION 3
 MOUNTED EXTERNALLY ON END

PRODUCT: FASTLANE PLUS S400 OT	
TITLE: ADDITIONAL CARD READER OPTIONS	
DRAWN: RST	DRAWING No: S665_644_A0
DATE: 20.1.09	This document is the copyright of Integrated Design Ltd

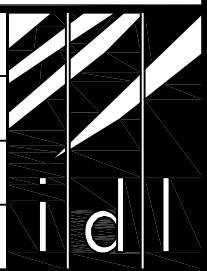

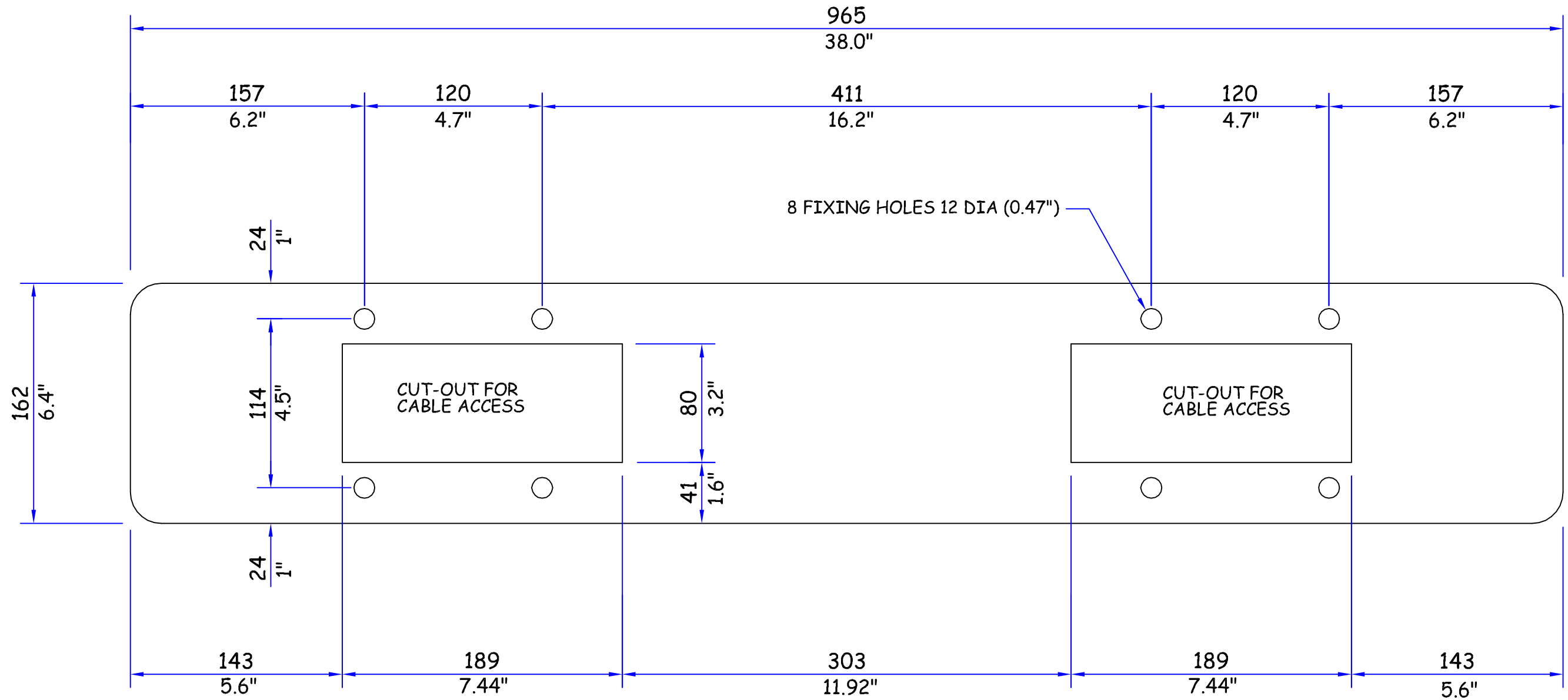

NOTE: UNIT IS TO BE SECURED TO THE FLOOR USING 10mm (0.39") DIA FIXINGS SUITABLE FOR THE FLOOR STRUCTURE.

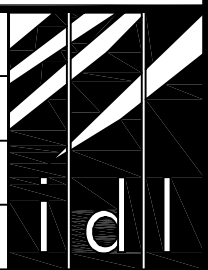
PRODUCT: FASTLANE PLUS S400 OT		
TITLE: BASE DRILLING TEMPLATE		
DRAWN: RST	DRAWING No: S665_645_A0	
DATE: 20.1.09	This document is the copyright of Integrated Design Ltd	

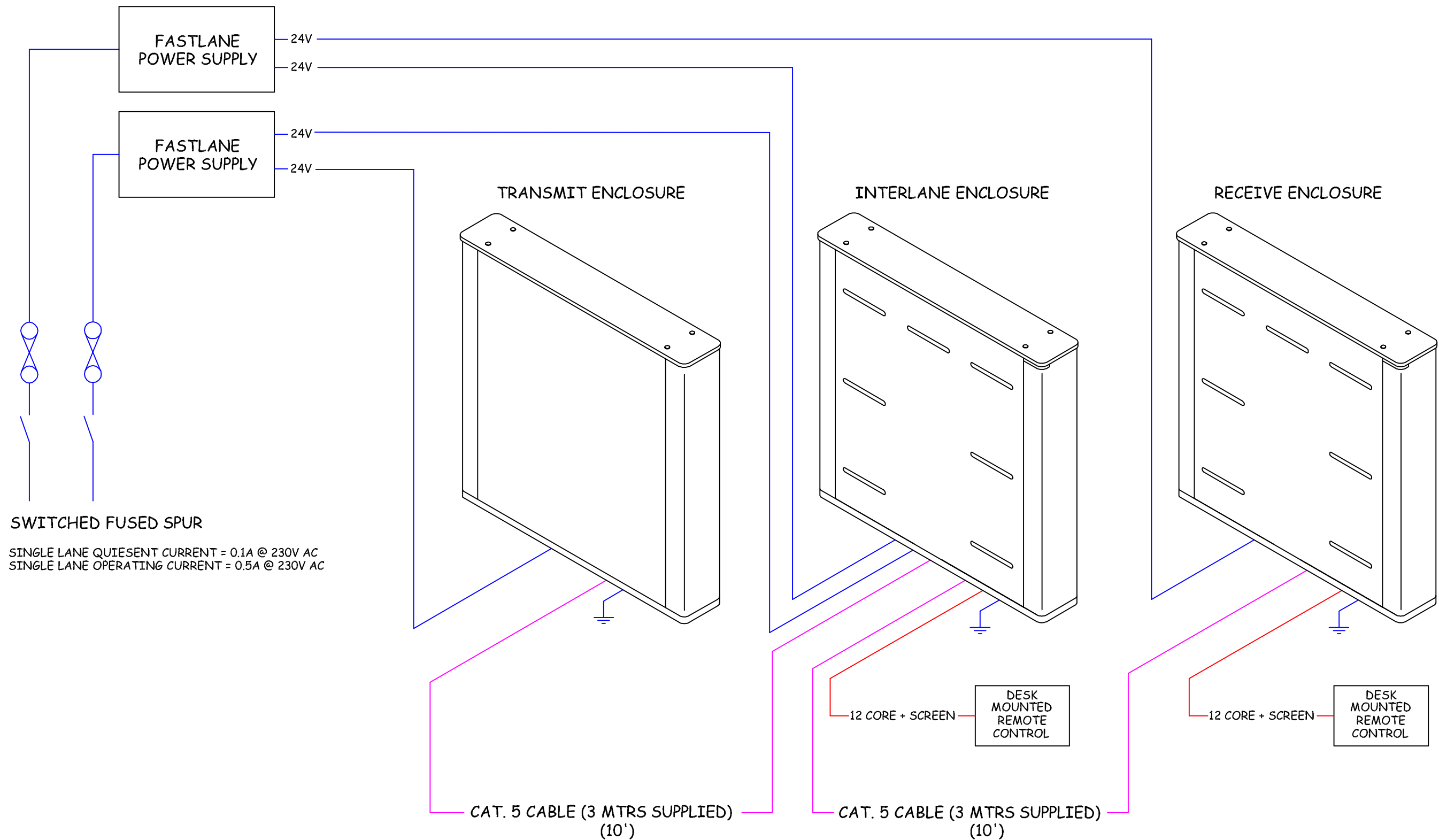

THIS DRAWING SHOWS THE FASTLANE PLUS CABLING REQUIREMENTS. IT IS TO BE READ IN CONJUNCTION WITH DRAWING 665_648_A0, WHICH SHOWS THE CABLING REQUIREMENTS FOR THE ACCESS CONTROL INTEGRATION. FOR FURTHER INFORMATION, REFER TO THE INSTALLATION MANUAL.

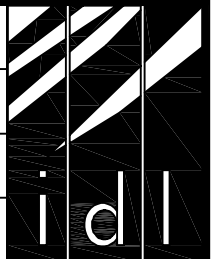
PRODUCT: FASTLANE PLUS S400 OT		
TITLE: CABLING REQUIREMENTS		
DRAWN: RST	DRAWING No: S665_647_A0	
DATE: 20.1.09	This document is the copyright of Integrated Design Ltd	

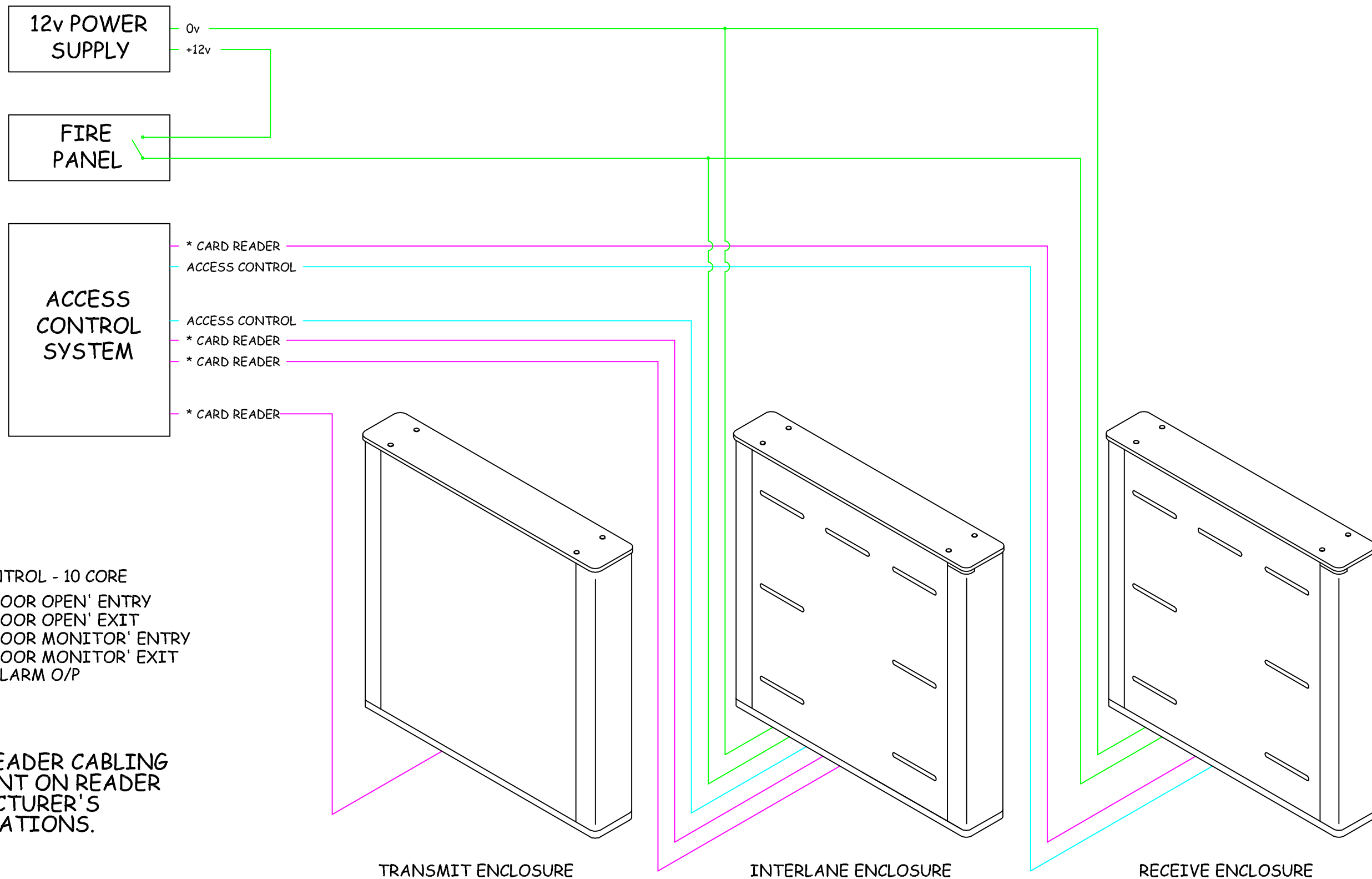

ACCESS CONTROL - 10 CORE

<IP 'DOOR OPEN' ENTRY
 IP> 'DOOR OPEN' EXIT
 <ENT 'DOOR MONITOR' ENTRY
 ENT> 'DOOR MONITOR' EXIT
 ALR ALARM O/P

* CARD READER CABLING
 DEPENDENT ON READER
 MANUFACTURER'S
 SPECIFICATIONS.

THIS DRAWING SHOWS THE ACCESS CONTROL INTEGRATION REQUIREMENTS.
 IT IS TO BE READ IN CONJUNCTION WITH DRAWING 665_647_A0
 WHICH SHOWS THE FASTLANE PLUS CABLING REQUIREMENTS.

FOR FURTHER INFORMATION, REFER TO THE INSTALLATION MANUAL.

PRODUCT: FASTLANE PLUS S400 OT		
TITLE: CABLING REQUIREMENTS		
DRAWN: RST	DRAWING No: S665_648_A0	
DATE: 20.1.09	This document is the copyright of Integrated Design Ltd	