

OVERALL FINISHED WEIGHT OF PEDESTAL - TBA

PRODUCT: GLASSWING COMPACT - ELLIPTICAL	
TITLE: GENERAL DIMENSIONS	
DRAWN: RST	DRAWING No: S665_500_A0
DATE: 27.3.08	This document is the copyright of Integrated Design Ltd

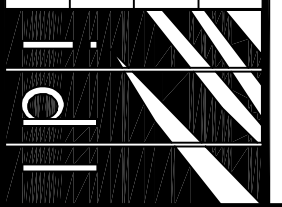

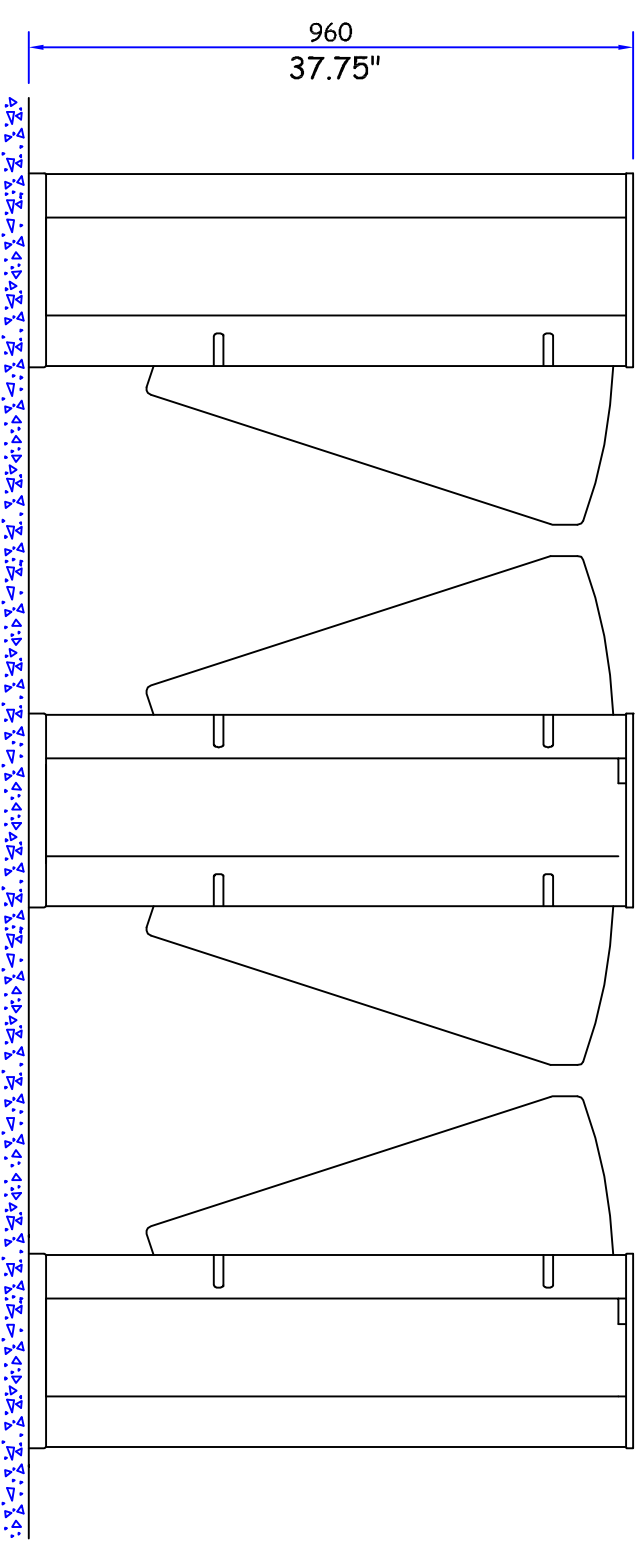
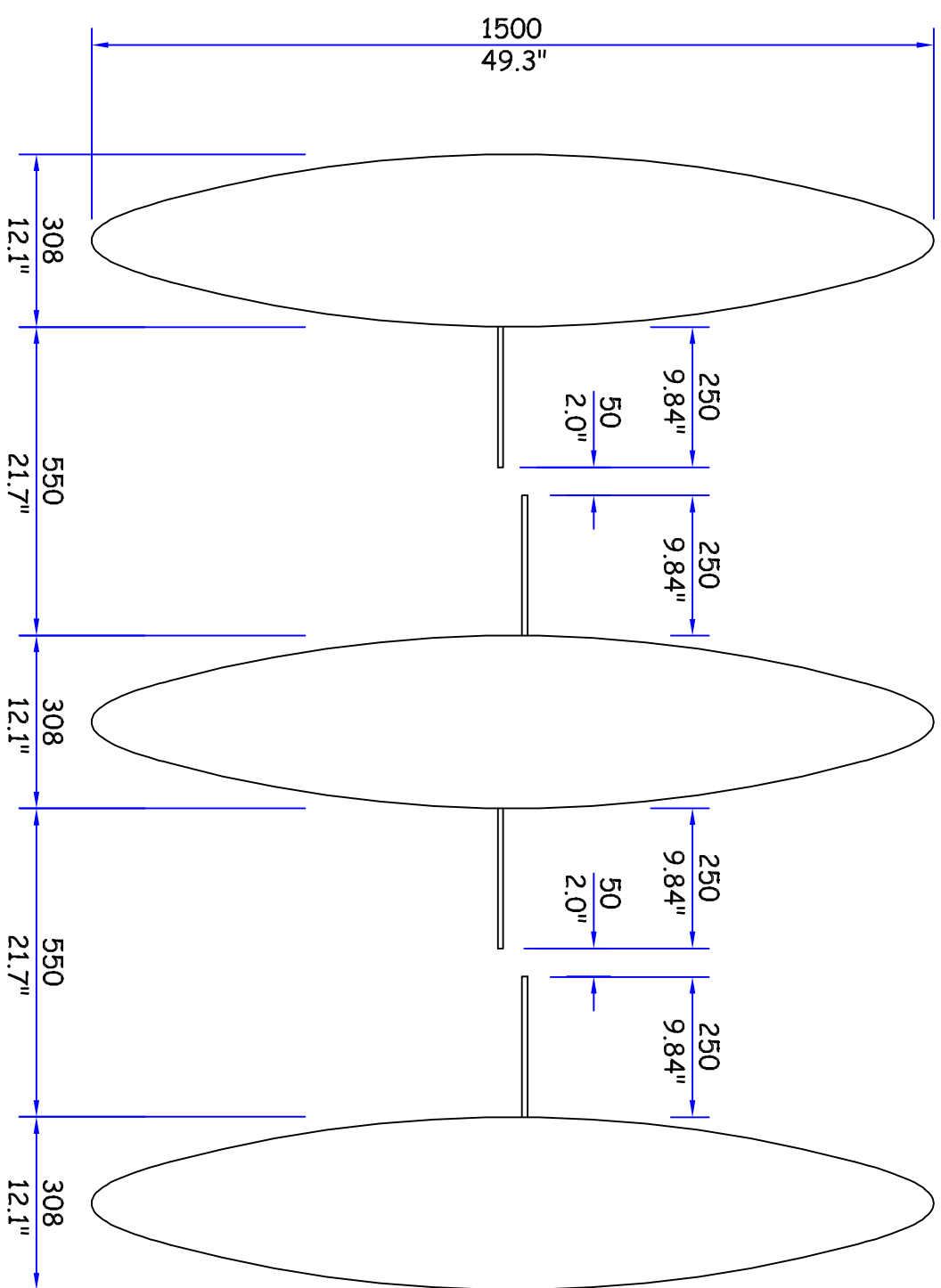

PRODUCT: GLASSWING COMPACT - ELLIPTICAL	
TITLE: GENERAL LAYOUT	
DRAWN: RST	DRAWING No: S665_501_A0
DATE: 27.3.08	This document is the copyright of Integrated Design Ltd

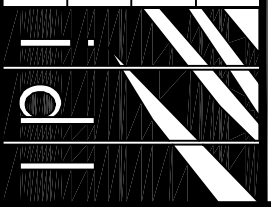

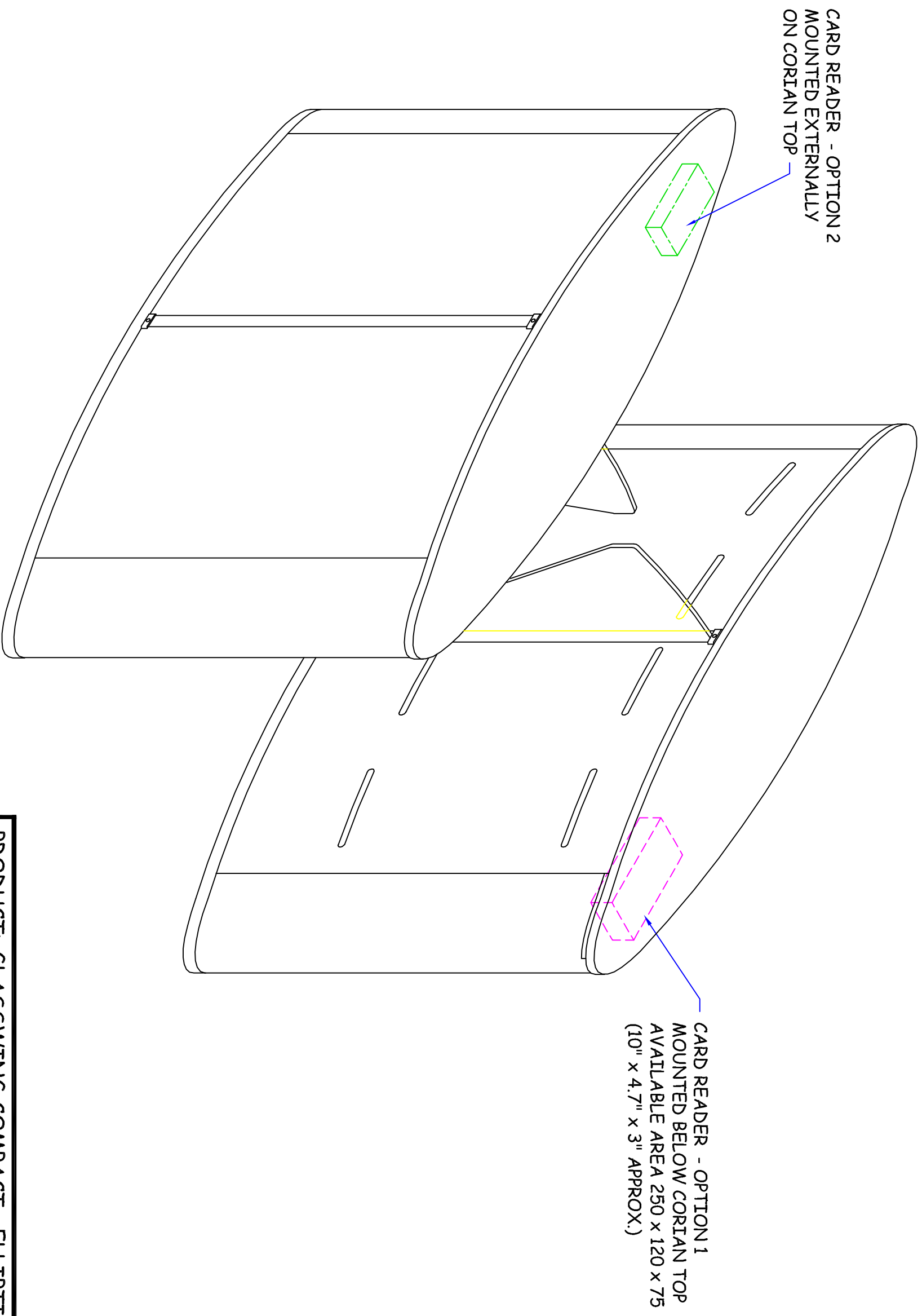

PRODUCT: GLASSWING COMPACT - ELLIPTICAL	
TITLE: CARD READER OPTIONS	
DRAWN: RST	DRAWING No: S665_503_A0
DATE: 27.3.08	This document is the copyright of Integrated Design Ltd

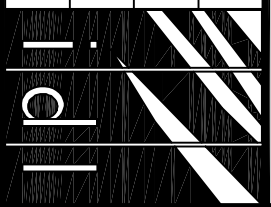

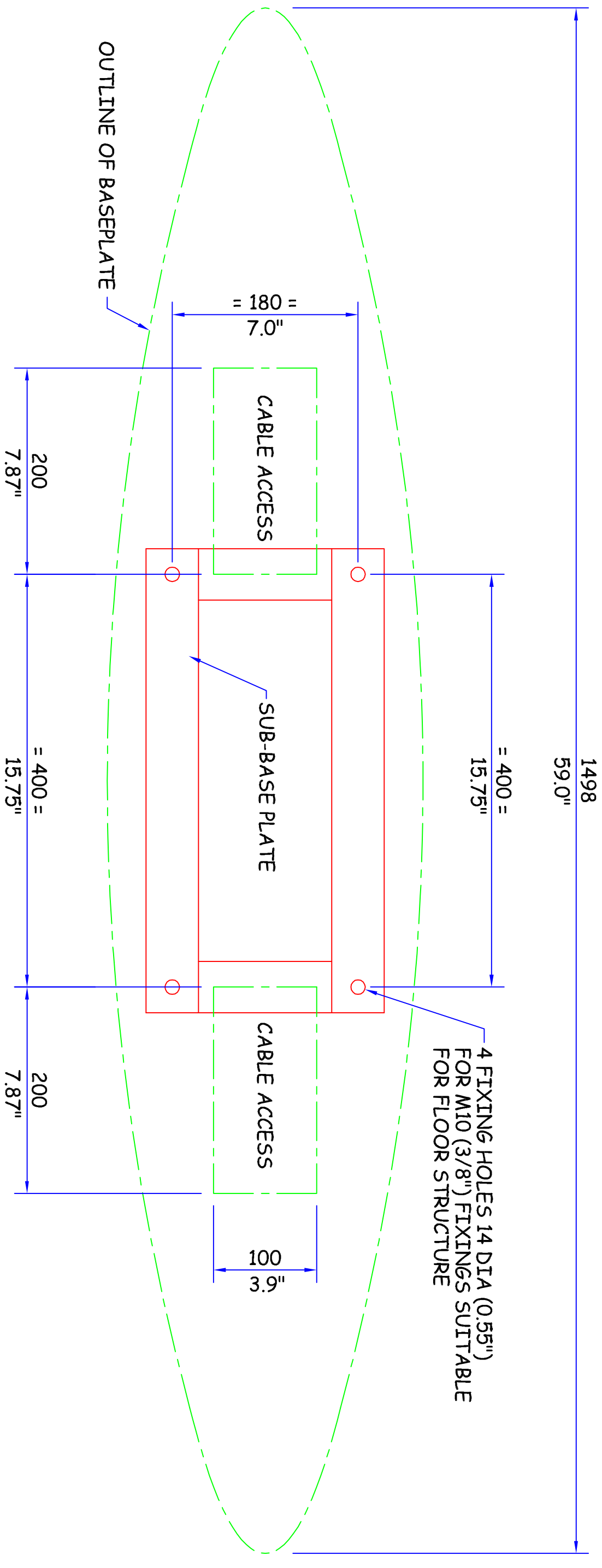

PRODUCT: GLASSWING COMPACT - ELLIPTICAL

TITLE: BASE DRILLING DETAILS

DRAWN: RST DRAWING No: S665_504_A0

DATE: 26.3.08

This document is the copyright of
Integrated Design Ltd



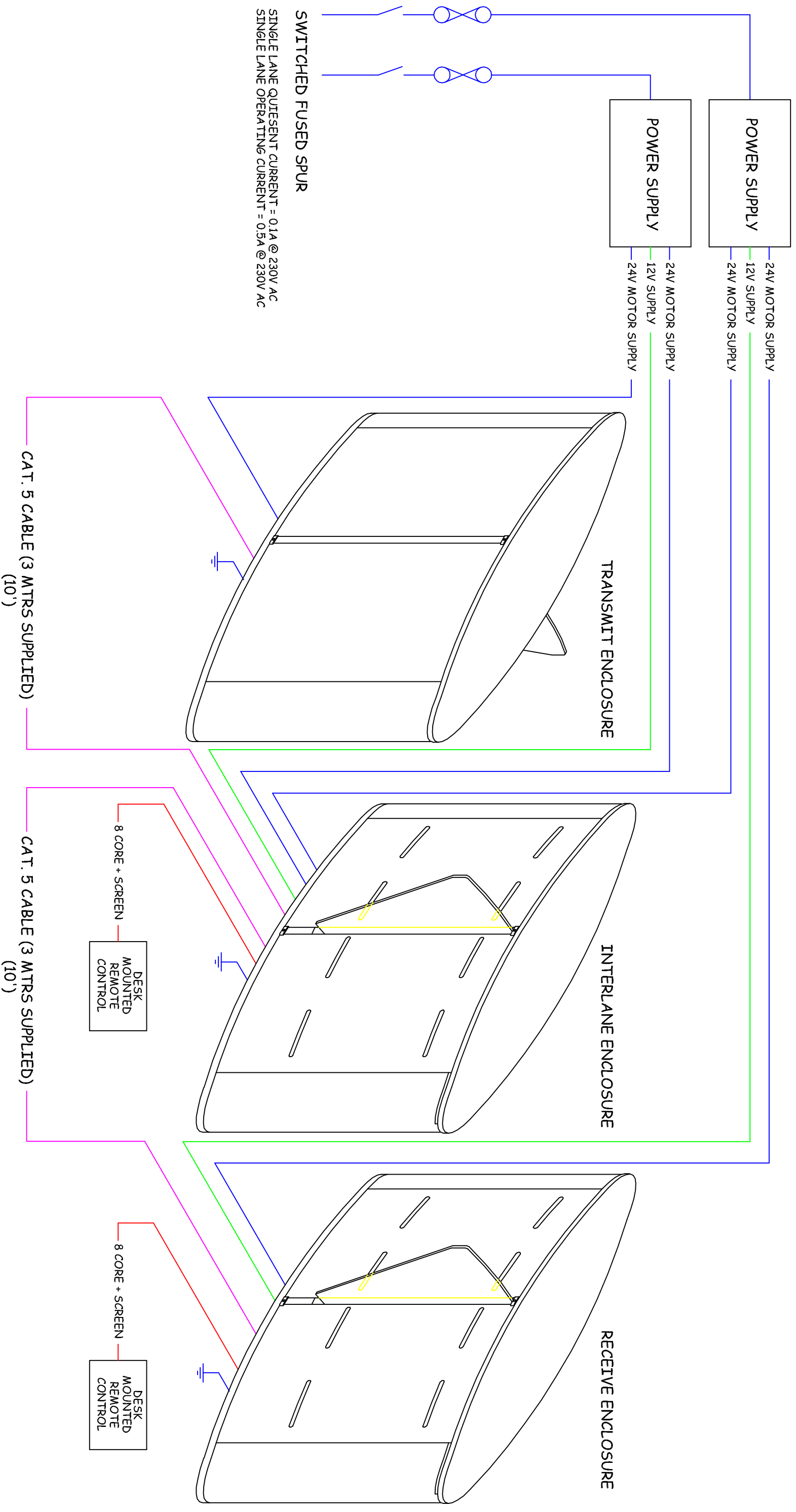

THIS DRAWING SHOWS THE GLASSWING CABLING REQUIREMENTS. IT IS TO BE READ IN CONJUNCTION WITH DRAWING 665_508_A0, WHICH SHOWS THE CABLING REQUIREMENTS FOR THE ACCESS CONTROL INTEGRATION. FOR FURTHER INFORMATION, REFER TO THE INSTALLATION MANUAL.

PRODUCT: GLASSWING COMPACT - ELLIPTICAL	
TITLE: CABLING REQUIREMENTS	
DRAWN: RST	DRAWING No: 5665_507_A0
DATE: 27.3.08	This document is the copyright of Integrated Design Ltd



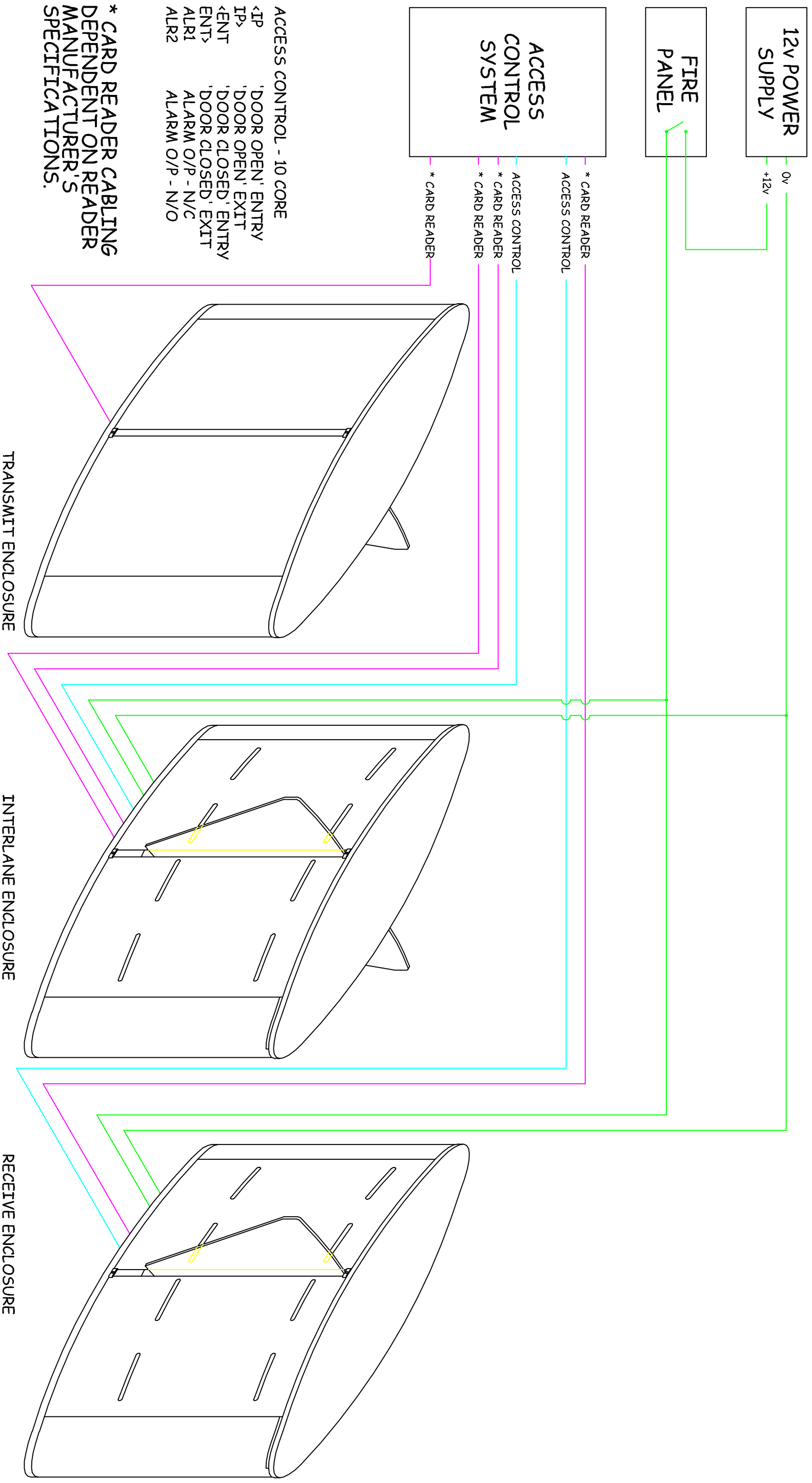

THIS DRAWING SHOWS THE ACCESS CONTROL INTEGRATION REQUIREMENTS. IT IS TO BE READ IN CONJUNCTION WITH DRAWING 665_507_A0 WHICH SHOWS THE GLASSWING CABLING REQUIREMENTS.

FOR FURTHER INFORMATION, REFER TO THE INSTALLATION MANUAL.

PRODUCT: GLASSWING COMPACT - ELLIPTICAL	
TITLE: CABLING REQUIREMENTS	
DRAWN: RST	DRAWING No: 5665_508_A0
DATE: 27.3.08	

This document is the copyright of
Integrated Design Ltd

